



GENERAL PURPOSE THYRISTOR MODULE

Features:

- . Electrical insulation between chip and base plate, 2500V AC insulation
- . Compact structure
- . Excellent temperature characteristics and power cycling capability
- . Small size & light weight

Typical application:

- . AC / DC motor control
- . Various rectification power supplies
- . Frequency converter



ELECTRICAL CHARACTERISTICS AND RATINGS

Symbol	Parameter	Conditions	Tj(°C)	Value			Unit
				Min	Typ	Max	
I _{T(AV)}	Mean on-state current	Sinewave 180°,50Hz Single side cooling, T _c =85°C	125			250	A
I _{T(RMS)}	RMS on-state current		125			392	A
V _{DRM} V _{RRM}	Repetitive peak off-state voltage Repetitive peak reverse voltage	V _{DRM} &V _{RRM} tp=10ms V _{DSM} &V _{RSM} =V _{DRM} &V _{RRM} +200V	25	1200		2000	V
I _{DRM}	Repetitive peak off-state current	V _{DM} = V _{DRM}	125			25	mA
I _{RRM}	Repetitive peak reverse current	V _{RM} = V _{RRM}					
I _{TSM}	Surge on-state current	10ms bottom width, half sine wave	125			8.50	KA
I ² t	I squared t	V _R =0.6V _{RRM}				361	A ² s*10 ³
V _{TO}	On-state threshold voltage		125			0.80	V
r _T	Slope resistance					1.27	mΩ
V _{TM}	Peak on-state voltage	I _{TM} =750A	25			1.45	V
dv/dt	Critical rise rate of off-state voltage	V _{DM} =67%V _{DRM}	125			1000	V/μs
di/dt	Critical rise rate of on-state current	I _{TM} =500A Amplitude of gate trigger current I _{GM} = 1.5A Gate current rise time t _r ≤0.5 s	125			100	A/μs
I _{GT}	Gate trigger current	V _O =12V, R _L =3Ω	25	30		120	mA
V _{GT}	Gate trigger voltage			0.8		2.5	V
I _H	Holding current			20		150	mA
I _L	Latching Current					1000	mA
V _{GD}	Gate non-trigger voltage	V _{DM} =67%V _{DRM}	125	0.2			V
R _{th(j-c)}	Thermal impedance(junction to case)	180°sine wave, single side heat dissipation				0.140	°C /W
R _{th(c-h)}	Thermal impedance(case to heatsink)	180°sine wave, single side heat dissipation				0.04	°C /W
V _{iso}	Insulation voltage	50Hz,R.M.S,t=1min,I _{iso} :1mA(MAX)		2500			V
F _m	Electrode mounting torque (M6)					12	N·m
	Base plate mounting torque (M6)					6	N·m
T _{stg}	Storage temperature			-40		125	°C
W _t	Weight					870	g

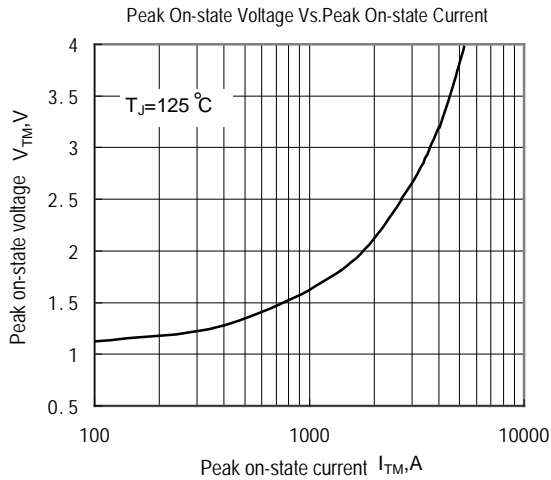

Fig.1 On-state Volt-ampere Characteristic

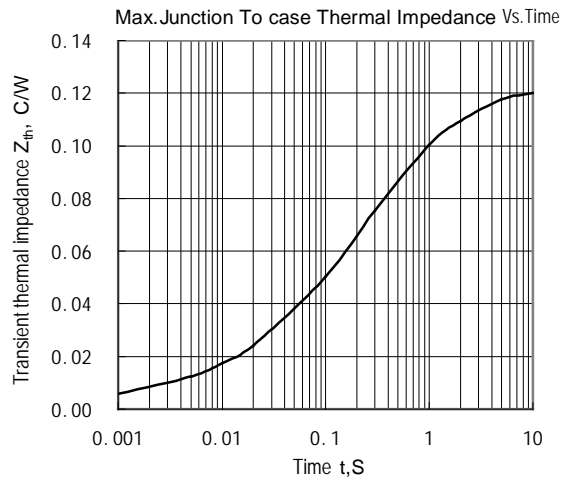

Fig.2 Transient Thermal Impedance of Junction to Case

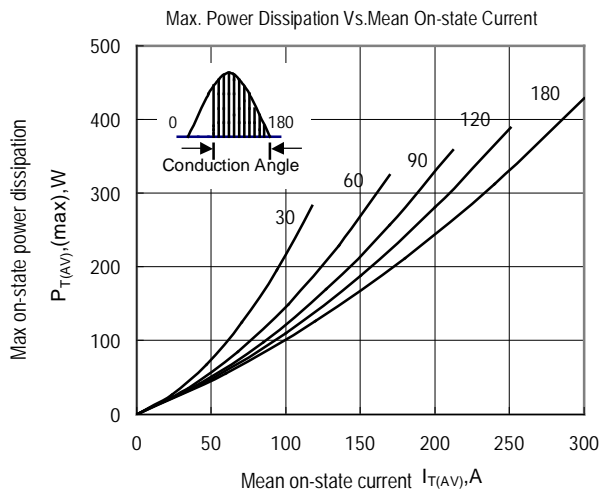

Fig.3 Max Power Dissipation Vs. Mean On-state Current

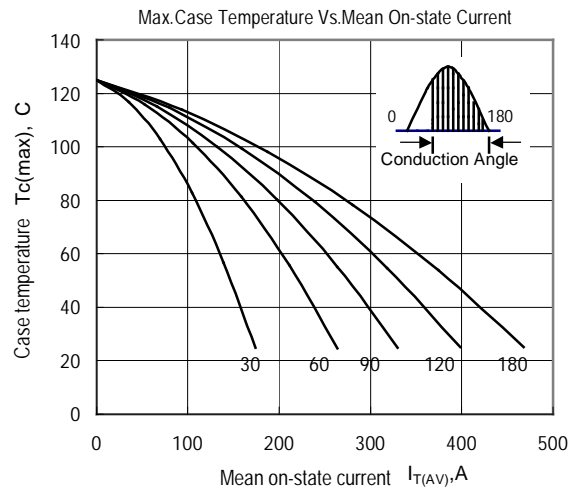

Fig.4 Max case Temperature Vs. Mean on-state Current

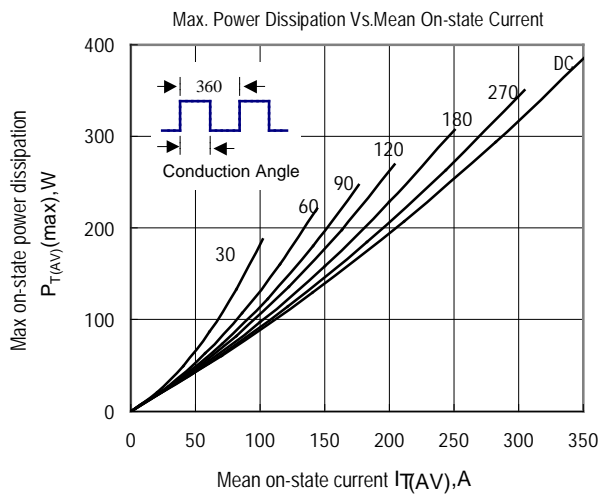

Fig.5 Max Power Dissipation Vs. Mean On-state Current

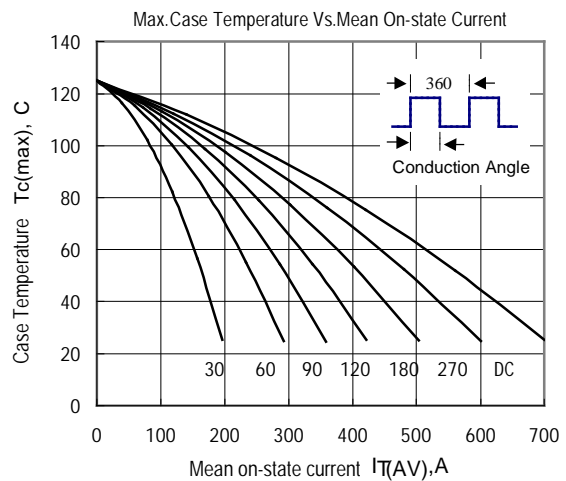

Fig.6 Max Case Temperature Vs. Mean On-state Current

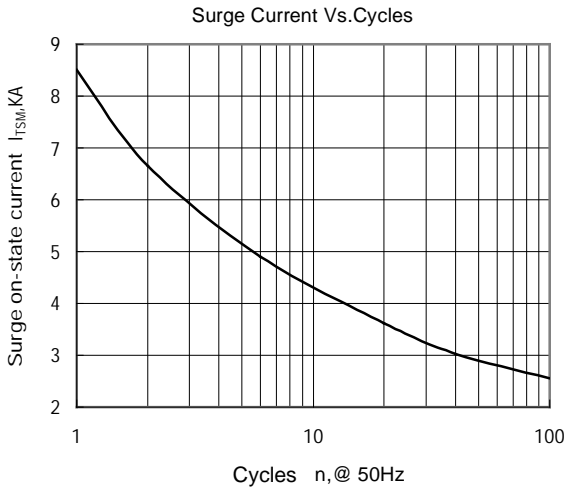

Fig.7 Surge Current Vs.Cycles

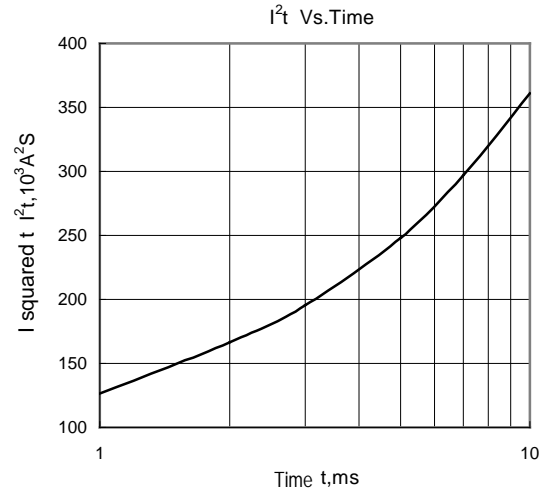

Fig.8 I^2t Vs.Time

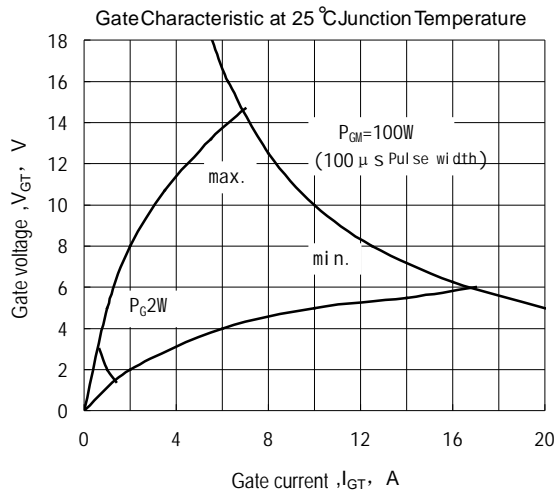

Fig.9 Gate Power Graph

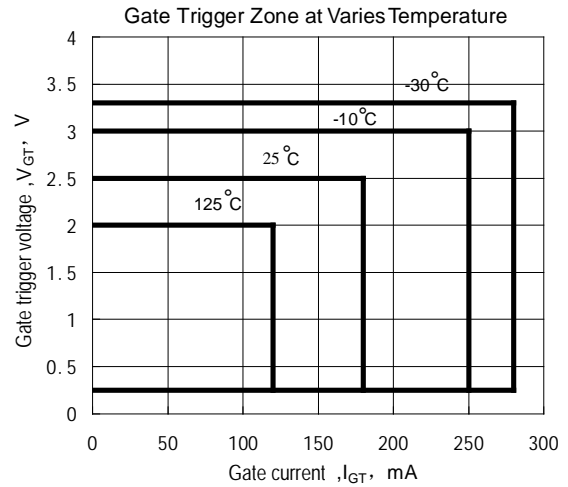
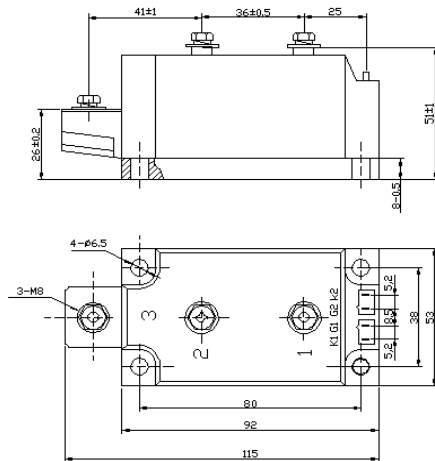

Fig.10 Gate Trigger Characteristic Graph

OUTLINE



M453F

